

• MATERIALS:(RoHS Compliant)

Hood: Plastic Thermoplastic PBT UL 94V-0
 Latch & Hood: Plastic Thermoplastic PBT UL 94V-0
 Latch: Stainless Steel
 Jackscrews: Steel Nickel Plated Over Copper
 Hex Nuts: Steel Nickel Plated Over Copper
 Cable Clipper: Steel Nickel Plated Over Copper
 Screws: Steel Nickel Plated Over Copper

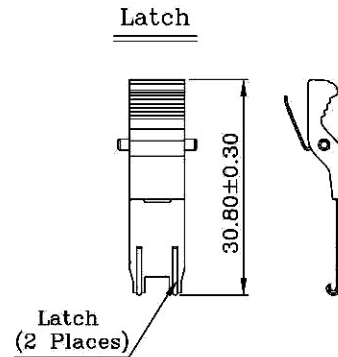
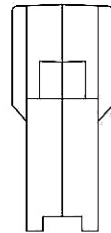
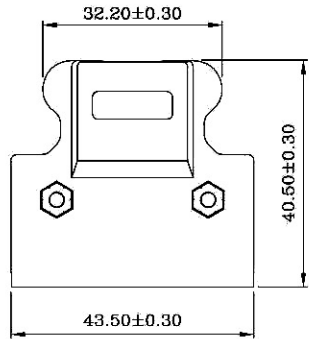
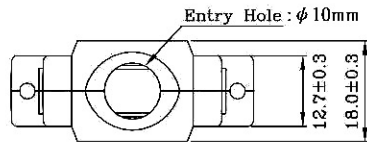
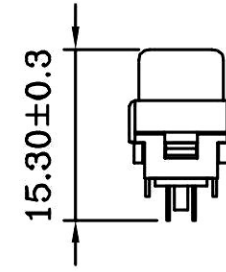
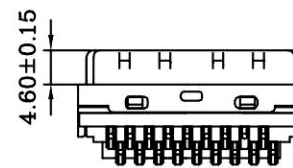
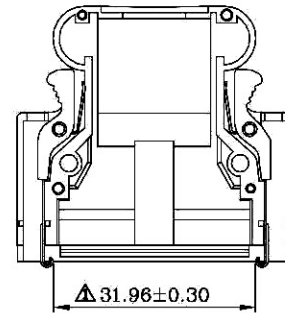
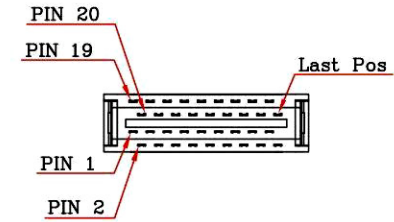
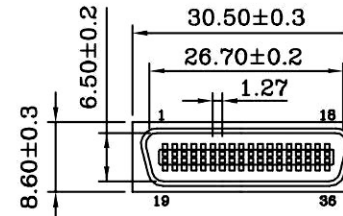
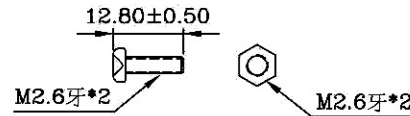

• MATERIALS: (RoHS Compliant)

Housing: Plastic Thermoplastic P.B.T UL94V-0 Black
 Contacts: Phosphor Bronze Gold Selective Plated
 Front Shell: Steel Nickel Plated Over Copper

• ELECTRICAL CHARACTERISTICS:

Contact Current Rating: 0.5 Amp
 Dielectric Withstanding Voltage: 500V AC
 Insulation Resistance: >500MΩ/Min
 Contact Resistance: 35mΩ/Max
 Operation Temperature: -55°C ~ +85°C

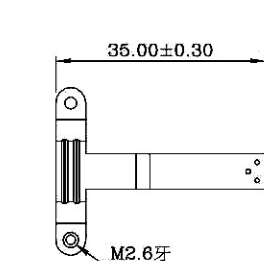
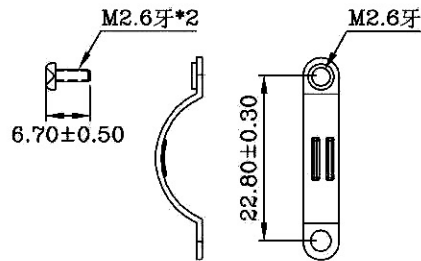

RoHS Compliant

HSM 玄茂科技股份有限公司
 HSUAN MAO TECHNOLOGY CO., LTD.

APPD. 核准 BETTY	TOLERANCE 容許公差 0 ± .00 ± ANG ±	PART NAME 品名 1.27mm SCSI II GEN. SOLDER CONNECTOR 36P MALE FISH HOOK SPRING LATCHES (STAINLESS STEEL T=0.3mm ENTRY HOLE SIZE:φ10mmHOOD:BLACK COLOR ROHS
DWG. 製圖 KAREN		
DATE 制表日 2014/08/07	UNIT 單位 MM	SIZE 線規尺寸 A4
	PAGE 張數 1 OF 1	REV. 版本 A

PART NO. 料號	C0510-36MGLXB0R
----------------	-----------------

PART NO. 料號	C0510-36MGLXB0R
----------------	-----------------