

SPECIFICATION

MATERIAL

Insulator : PA
 Contacts : Brass
 Outer Contacts : Brass

CONTACT PLATING

Contact area: 6u" Selective gold
 Solder tails area: 80u"~160u" Tin (Lead Free)

ELECTRICAL

Impedance, differential mode : 100Ω differential signaling, for one pair or quad cable shielded.

Frequency : DC to 2.0 GHz
 Return loss : ≥ 20 dB to 1.0 GHz
 ≥ 17 dB to 2.0 GHz





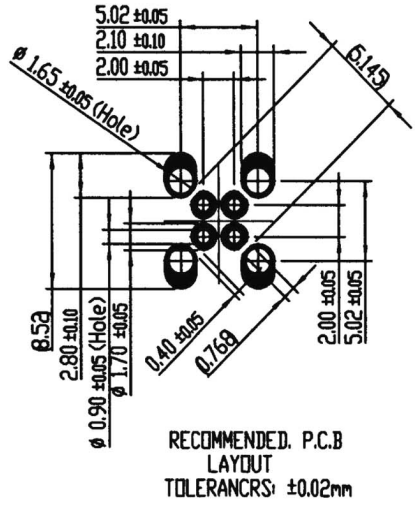

Insertion loss : ≤ 0.1 dB @ 1.0 GHz
 Insertion resistance: ≥ 1000MΩ
 Signa contact resistance : ≤ 10mΩ

MECHANICAL

Mating Cycles : ≥ 25 Cycles
 Engagement force : ≤ 30N
 Disengagement force : ≥ 5N
 Retention force latch : ≥ 110N
 Coding efficiency : ≥ 80N
 Temperature range : -40°C To +105°C



RoHS Compliant		玄茂科技股份有限公司 HSUAN MAO TECHNOLOGY CO., LTD.	
APPD. 核准	SCALE 比例 参考	UNLESS OTHERWISE SPECIFIED TOLERANCE ANG. ±.5 0.0 ±.50 .00 ±.20	PART NAME 品名 HSD PLUG 180° FOR DIP PCB CONTACTS MATERIAL:BRASS, CONTACTS AREA:GOLD 6U",DIP AREA:MATTE TIN SHELL PLATING:MATTE TIN INSULATOR MATERIAL:PA PAD+REEL PACKING ROHS
DWG. 製圖 Betty	UNIT 單位 M M	SIZE: 紙張尺寸 A 4	PART NO. 料號 C4003-04MSM6ZJXQR
DATE 制表日 2019/07/02	PAGE 張數 1 OF 2	REV. 版次 A	

Coding	A	B	C	D	E	F	Z
Plug							
Colour	black	white	blue	bordeaux	green	brown	waterblue
RAL	sim.9005	sim.9001	sim.5005	sim.4004	sim.6002	sim.8011	sim.5021

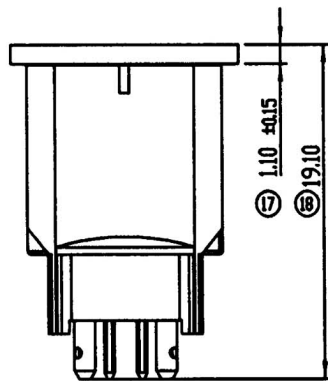
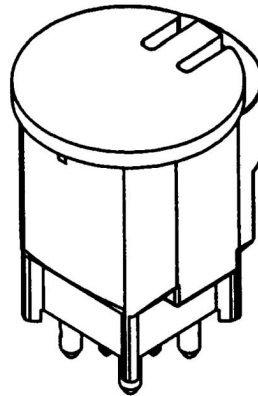
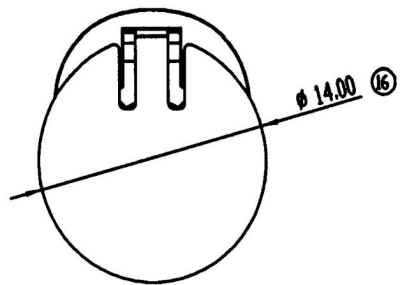

Straight Plug with Cap

RoHS Compliant	HSM 玄茂科技股份有限公司 HSUAN MAO TECHNOLOGY CO., LTD.	
APPD. 核准		UNLESS OTHERWISE SPECIFIED TOLERANCE ANG. ±5° 0.1 ±0.50 0 ±0.30 0.00 ±0.20
DWG. 製圖	SCALE 比例	PART NAME 品名 HSD PLUG 180° FOR DIP PCB CONTACTS MATERIAL:BRASS, CONTACTS AREA:GOLD 6U",DIP AREA:MATTE TIN SHELL PLATING:MATTE TIN INSULATOR MATERIAL:PA PAD+REEL PACKING ROHS
DATE 制表日	UNIT 單位	SIZE. 紙張尺寸
2019/07/02	M M	A 4
	PAGE 張數	REV. 版次
	2 OF 2	A
		PART NO. 料號
		C4003-04MSM6ZJXQR