

NOTE:  
 1.ALL DIMENSIONS ARE IN MILLIMETERS.  
 2.GENERAL TOLERANCES MAX.±0.20mm.

- SPECIFICATIONS:
- 1.Rating :10μA 2V DC to 20mA 15V DC(Resistive load)
  - 2.Contact Resistance :100mΩ Max.
  - 3.Insulation Resistance :DC 100V 100MΩ
  - 4.Dielectric Strength :AC 250V 1 minute
  - 5.Life: 100,000 CYCLES
  - 6.Operating Temperature Range: -40°~85°C  
Storage Temperature Range: -40°~85°C

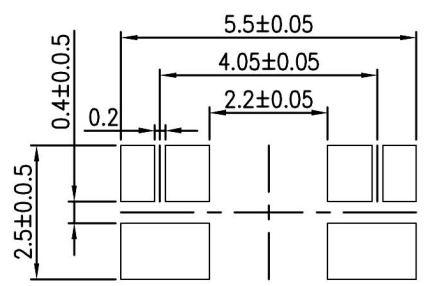

Solder mask B

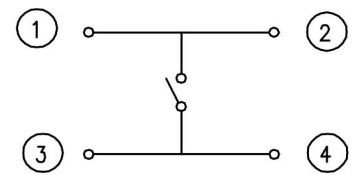

CIRCUIT DIAGRAM

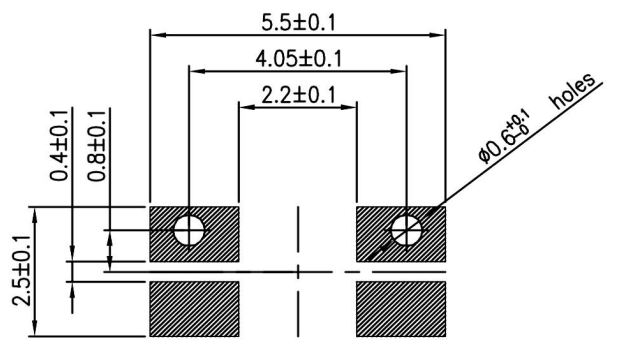
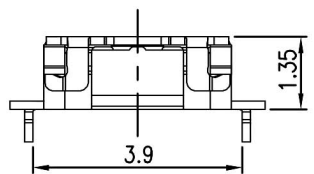

Recommended P.C.B Layout  
 Solder thicknss t=0.12<sup>+0.03</sup><sub>-0.02</sub>

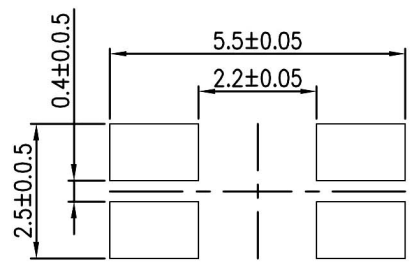

Solder mask A

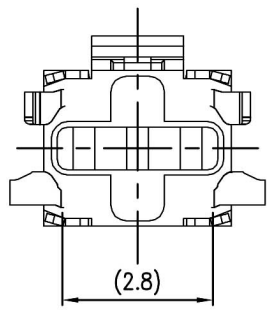

Operating Force	Part No.
160 <sup>±7%</sup> gf	C8715-BBBR0000R
220 <sup>±8%</sup> gf	C8715-JBBR0000R

RoHS Compliant		HSM 玄茂科技股份有限公司 HSUAN MAO TECHNOLOGY CO., LTD.	
APPD. 核准	SCALE 比例	TOLERANCE 容許公差 .0 ± .00 ± ANG. ±	PART NAME 品名
DWG. 製圖	UNIT 單位	SIZE. 紙張尺寸	2.9X3.5mm TACT SWITCH SIDE PUSH TYPE WITHOUT GROUND PIN & WITHOUT POST BLACK COLOR REEL PACKING ROHS
DATE 制表日	PAGE 張數	REV. 版次	PART NO. 料號
2018/07/19	1 OF 2	A	C8715-XBBR0000R
Betty			

ITEM	DESC	Q'TY	METERIALS	TREATMENT	REMARK
1	PUSH BUTTON	1	HIGH-TEMP THERMOPLASTIC Vertical push LCP UL 94V-0 Side push PA46 UL 94HB	NONE	-
2	COVER	1	STAINLESS STEEL	Ground pin=WITH SILVER PLATING	-
3	BASE	1	HIGH-TEMP THERMOPLASTIC NYLON UL 94V-0	NONE	-
4	TERMINAL	1	PHOSPHOR BRONZE	WITH SILVER PLATING	-
5	DOME	1	STAINLESS STEEL	WITH SILVER CLADDING	-
6	TAPE	1	TEFLON	-	-

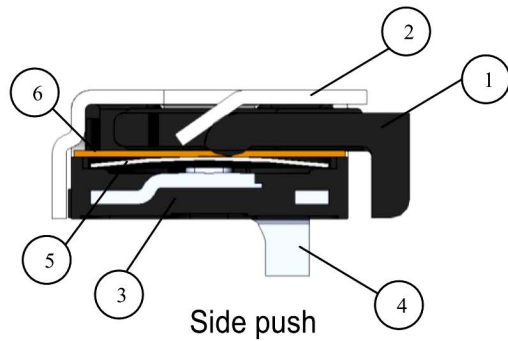

RoHS Compliant		<b>HSM</b> 玄茂科技股份有限公司 HSUAN MAO TECHNOLOGY CO., LTD.	
APPD. 核准		TOLERANCE 容許公差	PART NAME 品名
DWG. 製圖	Betty	SCALE 比例 參考	2.9X3.5mm TACT SWITCH SIDE PUSH TYPE WITHOUT GROUND PIN & WITHOUT POST BLACK COLOR REEL PACKING ROHS
DATE 制表日	2018/07/19	UNIT 單位 M M	PART NO.
		PAGE 張數 2 OF 2	料號 C8715-XBBR0000R
		REV. 版次 A	