

1 2 3 4 5 6 7 8

A
B
C
D
E
F
G
H

A
B
C
D
E
F
G
H

TYPE	H	H	TYPE
A	4.3	5.0	B
K	6.0	7.0	C
N	7.5	8.0	D
S	9.0	9.5	E
W	10	11	Y
Z	12	...	

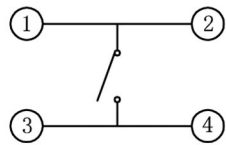

CIRCUIT DRAWING

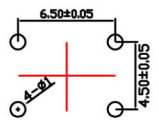
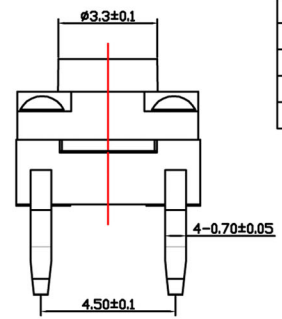
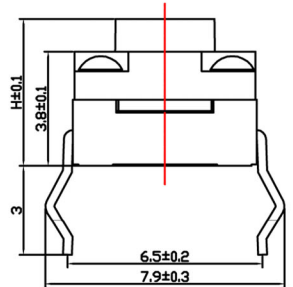
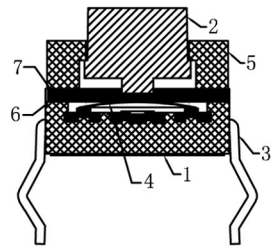

P. C. B HOLE

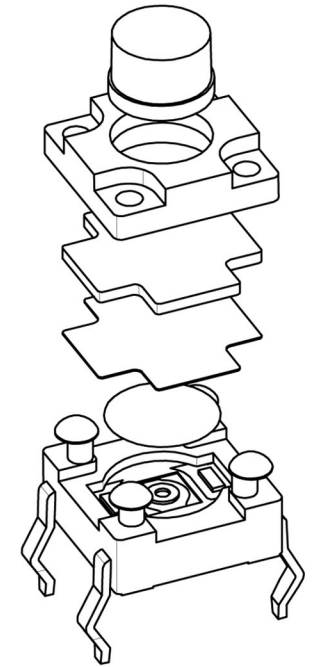
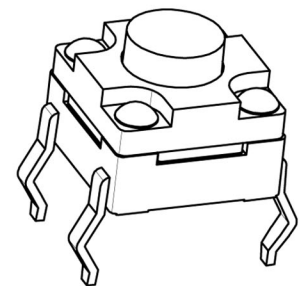
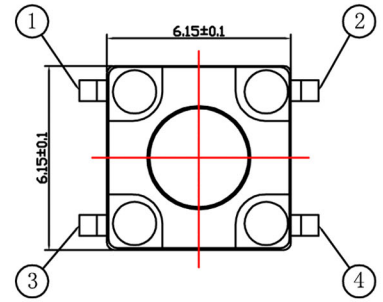

- 1. Rating : 50mA DC12V
- 2. Contact Resistance: $\leq 100m\Omega$
- 3. Operation Force : $250 \pm 50gf$
- 4. Travel Toclosure : $0.25 \pm 0.1mm$
- 5. Insulation Resistance: $\geq 100M\Omega$
- 6. Withstand Voltage: 250V 50HZ 1Min.
- 7. Life Test: 100,000 Cycles

- 1. Housing: PPA (Black)
- 2. Button: PPA (Black)
- 3. Contact: Brass (Plating Silver)
- 4. Shrapnel: Stainless Steel (Plating Silver)
- 5. Cover: PPA (Black)
- 6. Waterproof Layer: EP (Orange/Yellow)
- 7. Waterproof Glue: Silica Gel (Black)

RoHS Compliant				HSM 玄茂科技股份有限公司 HSUAN MAO TECHNOLOGY CO., LTD.	
				PART NAME 品名 6.0X6.0mm IP67 WASHABLE TYPE TACT SWITCH THROUGH HOLE TYPE KONB HEIGHT:XXXmm OPERATING FORCE:250gf BUTTON COLOR:BLACK COLOR BAG PACKING ROHS	
APPD. 核准 DWG. 製圖 Hedy	SCALE 比例 參考	TOLERANCE >0.5-2 ±0.10 >2-5 ±0.25 >5-10 ±0.30 角度 ±0.5°	UNIT 單位 MM	SIZE. 紙張尺寸 A 4	PART NO. 料號 C8724-XCBB0000R
DATE 制表日 2019/01/10	PAGE 張數 1 / 1	REV. 版次 A			

1 2 3 4 5 6 7 8