

1 2 3 4 5 6 7 8

A
B
C
D
E
F
G
H

A
B
C
D
E
F
G
H

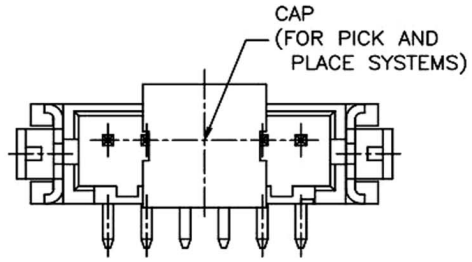

TO MAKE SURE THE CAP CAN BE PUT ON THE MIDPOINT FOR 04P TO 15P.

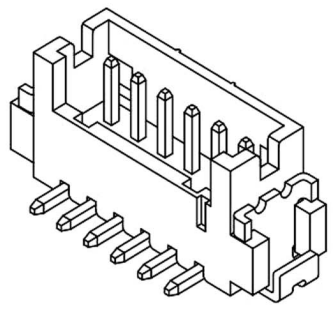
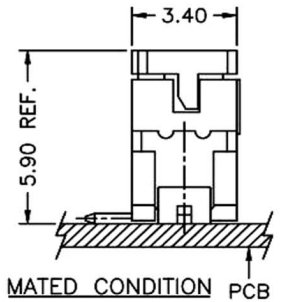
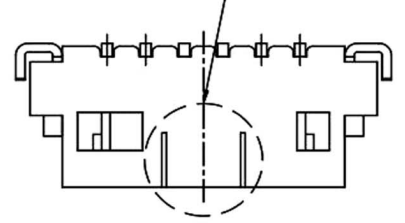

SPECIFICATIONS
 Current Rating: 1A AC,DC
 Voltage Rating: 150V AC,DC
 Temperature Range: -25°C ~ +85°C
 Contact Resistance: 30mΩ Max.
 Insulation Resistance: 500MΩ Min.
 Withstanding Voltage: 500V AC/minute
 Pin Material: Brass
 Solder Tabs: Phosphor Broze
 Wafer: Nylon 6T,UL94V-0
 Cap: Nylon 6T,UL94V-0

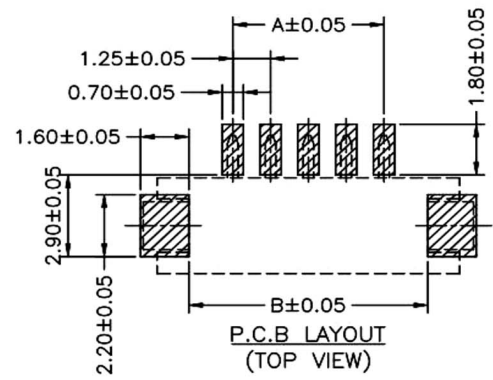
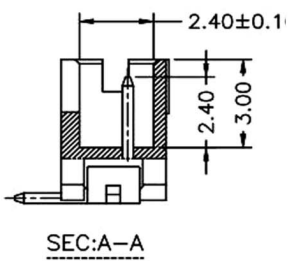
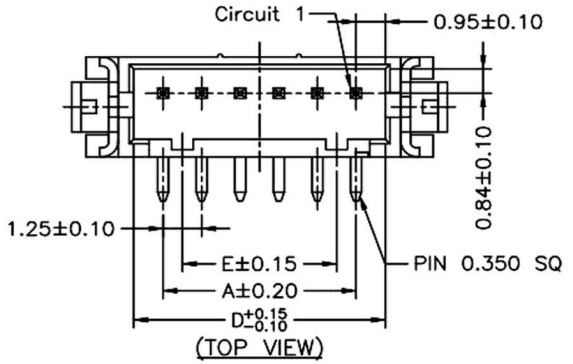

Circuit No.	Dimensions				
	A	B	C	D	E
02P	1.25	4.15	6.25	3.15	---
03P	2.50	5.40	7.50	4.40	1.25
04P	3.75	6.65	8.75	5.65	2.50
05P	5.00	7.90	10.00	6.90	3.75
06P	6.25	9.15	11.25	8.15	5.00
07P	7.50	10.40	12.50	9.40	6.25
08P	8.75	11.65	13.75	10.65	7.50
09P	10.00	12.90	15.00	11.90	8.75
10P	11.25	14.15	16.25	13.15	10.00
11P	12.50	15.40	17.50	14.40	11.25
12P	13.75	16.65	18.75	15.65	12.50
13P	15.00	17.90	20.00	16.90	13.75
14P	16.25	19.15	21.25	18.15	15.00
15P	17.50	20.40	22.50	19.40	16.25

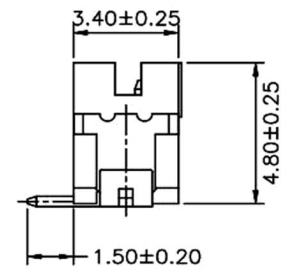
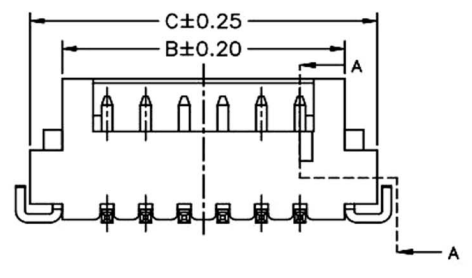

RoHS Compliant		HSM 玄茂科技股份有限公司 HSIUAN MAO TECHNOLOGY CO., LTD.	
APPD. 核准 Betty	SCALE 比例 参考 UNIT 單位 MM PAGE 張數 1 OF 2	TOLERANCE 容許公差 X. XX±0.25 X. XX±0.15 X. XXX±0.05 SIZE 紙張尺寸 A4 REV. 版次 A	PART NAME 品名 1.25mm WAFER 1XXXPin SMT TYPE STRAIGHT(TOP ENTRY) WITHOUT LOCATING PEG GOLD PLATING IVORY COLOR ROHS PART NO. 料號 W1355-XXPSAGINR
DATE 制表日 2016/02/05			

1 2 3 4 5 6 7 8